



Sun FLeX Series Solenoid Valves

HIGH RELIABILITY

Designed & tested to 10-million operational cycles at full rated pressure

ZINC-NICKEL COATING STANDARD

Offers 1,000-hour salt fog protection

USE WITH ANY OF THREE COILS

Energy-saving (3000 psi), high-power (5000 psi) & hazardous location coils

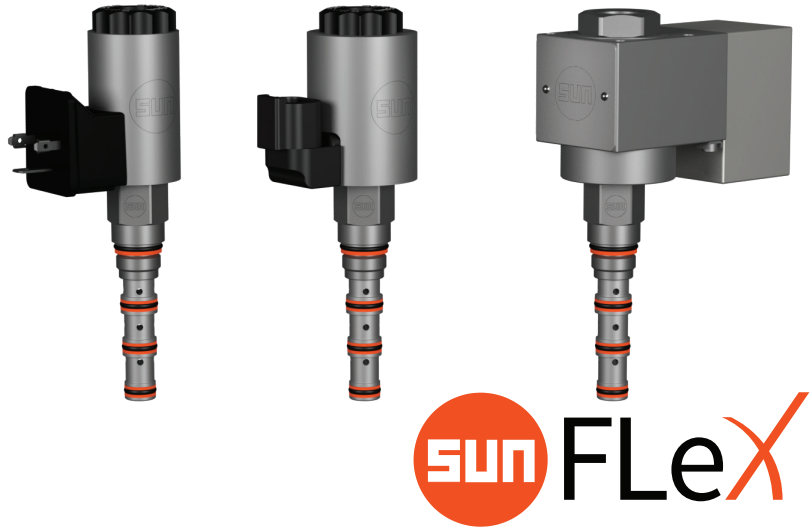

DNB*

5000/3000 psi (350/210 bar)
T-30A cavity

4-WAY, 2-POSITION
SOLENOID-OPERATED
DIRECTIONAL SPOOL VALVES

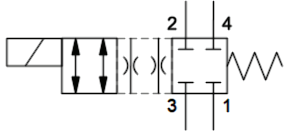

DNBF-XC*
5000 psi (350 bar)
DNBD-XC*
3000 psi (210 bar)

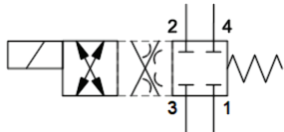

DNBF-XD*
5000 psi (350 bar)
DNBD-XD*
3000 psi (210 bar)

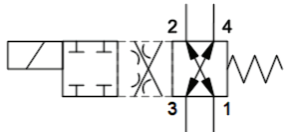

DNBF-XE*
5000 psi (350 bar)
DNBD-XE*
3000 psi (210 bar)

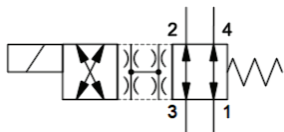

DNBF-XN*
5000 psi (350 bar)
DNBD-XN*
3000 psi (210 bar)

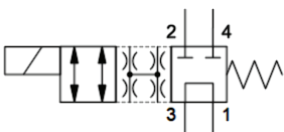

DNBF-XT*
5000 psi (350 bar)
DNBD-XT*
3000 psi (210 bar)

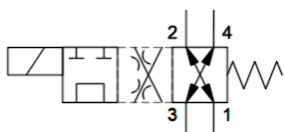

DNBF-XV*
5000 psi (350 bar)
DNBD-XV*
3000 psi (210 bar)

TABLE OF CONTENTS

Technical Features	2
Model Configurations & Options	3
Technical Specifications	4
Performance Curves	5
Dimensional Drawings	8
Cavity Drawing & Tooling	9
Additional Information	10

sunhydraulics.com/model/DNB*

DNB* 4-WAY, 2-POSITION SOLENOID-OPERATED DIRECTIONAL SPOOL VALVE

SERIES 0, CAVITY: T-30A

The 4-way, 2-position directional spool valves are direct acting. They comprise a hex body (3), solenoid with coil (2), spool (4), and a coil nut (1).

DNB*-XC* (C Spool)

Function: When de-energized, the spool (4) creates a blocked flow path in all directions. When energized, the spool (4) creates a bidirectional open flow path from 3 to 2 and 4 to 1.

DNB*-XN* (N Spool)

Function: When de-energized, the spool (4) creates a bidirectional open flow path from 3 to 2 and 4 to 1. When energized, the spool (4) creates a bidirectional open flow path from 3 to 4 and 2 to 1.

DNB*-XD* (D Spool)

Function: When de-energized, the spool (4) creates a blocked flow path in all directions. When energized, the spool (4) creates a bidirectional open flow path from 3 to 4 and 2 to 1.

DNB*-XE* (E Spool)

Function: When de-energized, the spool (4) creates a bidirectional open flow path from 3 to 4 and 2 to 1. When energized, the spool (4) creates a blocked flow path in all directions.

DNB*-XV* (V Spool)

Function: When de-energized, the spool (4) creates a bidirectional open flow path from 3 to 4 and 2 to 1. When energized, the spool (4) creates a bidirectional open flow path from 3 to 1 and blocks 2 and 4.

DNB*-XT* (T Spool)

Function: When de-energized, the spool (4) creates a bidirectional open flow path from 3 to 1 and blocks 2 and 4. When energized, the spool (4) creates a bidirectional open flow path from 3 to 2 and 4 to 1.

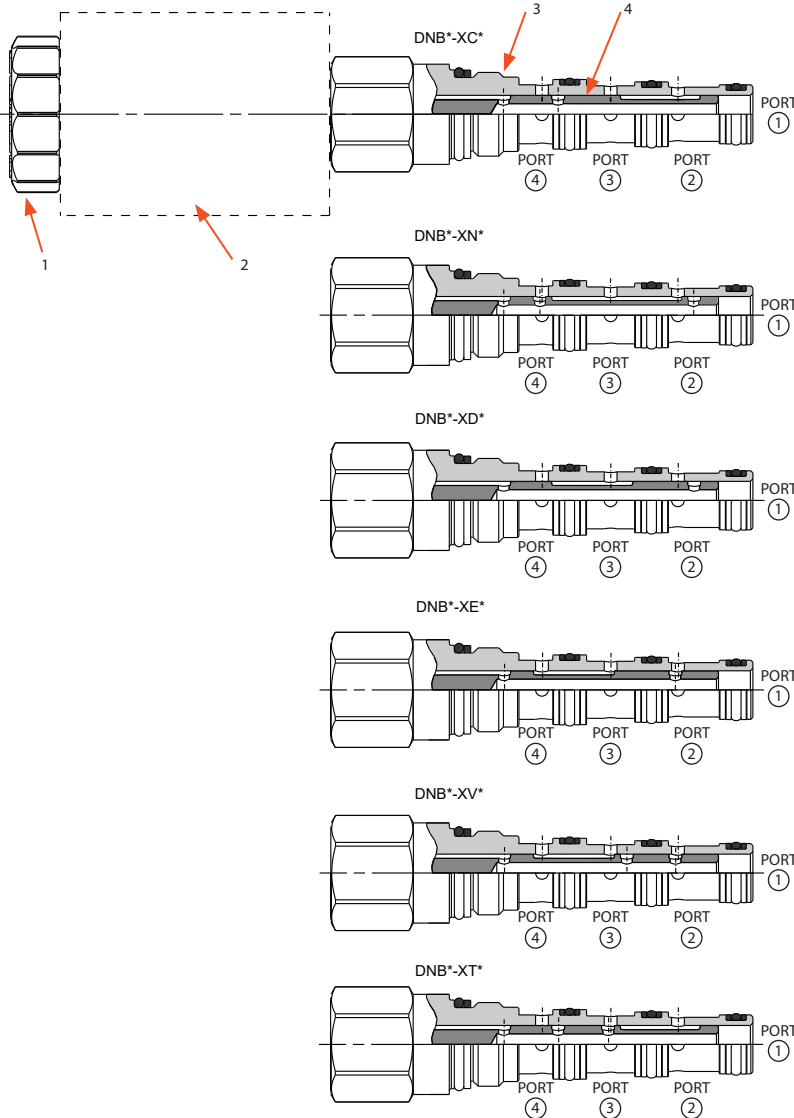

TECHNICAL FEATURES

- All FLeX Series valves incorporate the Sun floating-style construction to minimize the possibility of internal parts binding due to excessive installation torque and/or cavity/cartridge machining variations.
- Designed and tested to 10-million operational cycles at full rated pressure.
- Exceeds the new NFPA test standard T2.6.1 R2014 for fatigue and burst pressure ratings.
- Zinc-nickel plating standard for 1000-hour salt fog protection.
- Designed using CFD simulation for optimized geometries.
- A wide variety of coil termination and voltage options are available, with and without surge protection. See the CONFIGURATION section.
- Coil connector options offer ratings up to IP69K. See individual coil product pages for details.
- The 3000-psi (210-bar) DNBD valves use the low-power (17-W) coils; the 5000-psi (350-bar) DNBF valves use the high-power (25-W) coils. Note that all DNB* valves can be used with the hazardous location coils. See table on page 3.

MODEL CODE EXPLANATION

Sun cartridges have a base seven-digit part number. Each of the digits in the sequence has significance as shown in the model code explanation below. Available options and

modifiers for specific cartridges, manifolds, and valve packages are shown on the individual product pages and data sheets. Not all modifiers are applicable for every model.

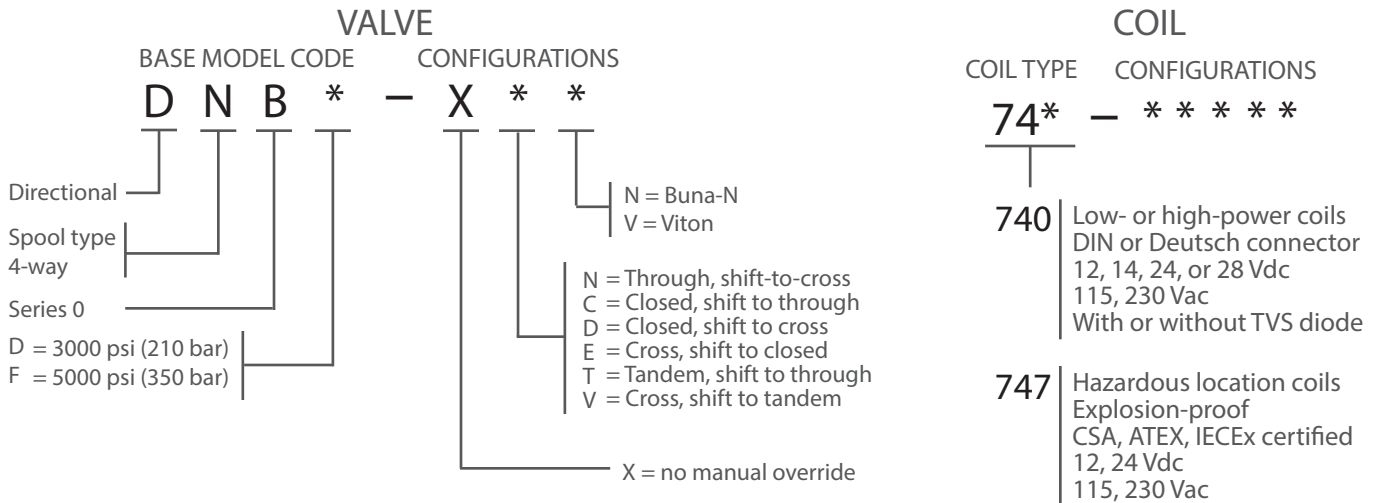

Important Note:

When performing model code searches on www.sunhydraulics.com, do not include setting(s). When ordering, no spaces or dashes are used.

See individual coil data sheets for full coil configuration.

COMPATIBLE COILS

The DNBD 3000-psi (210-bar) valves use the low-power (17-W) coils; the DNBF 5000-psi (350 bar) valves use the high-power (25-W) coils. Note that all DNB* valves can be used with the hazardous location coils.

High-Power (25-W) & Low-Power (17-W) Coils

Voltage	DIN 43650 Form A (IP65/IP67)		Deutsch DT04-2P (IP69K)		Resistance @20°C (ohms) ±10% (with diode**)		TVS Diode (Nominal) Breakdown Voltage (with diode*)
	High-Power	Low-Power	High-Power	Low-Power	High-Power	Low-Power	
12 Vdc	740-212	740-212L	740-912	740-912L	5.8 Ω	8.5 Ω	68 Vdc
14 Vdc	740-214	740-214L	740-914	740-914L	7.8 Ω	11.5 Ω	68 Vdc
24 Vdc	740-224	740-224L	740-924	740-924L	23.0 Ω	33.9 Ω	68 Vdc
28 Vdc	740-228	740-228L	740-928	740-928L	31.4 Ω	46.1 Ω	68 Vdc
115 Vac	740-211	740-211L	N/A	N/A	416 Ω	612 Ω	250 Vac
230 Vac	740-223	740-223L	N/A	N/A	1686 Ω	2479 Ω	400 Vac

** Above model codes are shown without transient voltage suppression (TVS) diodes. To order 740 Series coils with a TVS diode, append model code with "D" (Example: 740-212LD).

Hazardous Location, Explosion-Proof (30-W) Coils

Voltage	M20 x 1.5 180°	M20 x 1.5 90°	1/2" NPT 180°	1/2" NPT 90°	Wattage @ 20°C	Circuitry
12 Vdc	747-JM12BD	747-JM12CD	747-JN12BD	747-JN12CD	29.6 W	With diode
24 Vdc	747-JM24BD	747-JM24CD	747-JN24BD	747-JN24CD	29.9 W	With diode
115 Vac	747-JM11BD	747-JM11CD	747-JN11BD	747-JN11CD	29.7 W	Rectified
230 Vac	747-JM23BD	747-JM23CD	747-JN23BD	747-JN23CD	28.9 W	Rectified

DNB* 4-WAY, 2-POSITION SOLENOID-OPERATED
DIRECTIONAL SPOOL VALVE

SERIES 0, CAVITY: T-30A

TECHNICAL SPECIFICATIONS	DNBD	DNBF
Maximum Operating Pressure	3000 psi (210 bar)	5000 psi (350 bar)
Typical Internal Leakage at 110 SUS (24 cSt) (at maximum operating pressure)	N spool inlet on 3: 5 in ³ (80 cc)/min All other spools: 2 in ³ (30 cc)/min	N spool inlet on 3: 7 in ³ (110 cc)/min All other spools: 4 in ³ (65 cc)/min
Nominal Flow Rate / Capacity	4 gpm (15 L/min)*	4 gpm (15 L/min)*
Sun Cavity	T-30A	
Sun Cartridge Series	Series 0	
Response Time - Typical	50 ms (open & close)	
Switching Frequency - Maximum	4.17 Hz (15,000 cycles/hour)	
Viscosity Range	2,8 to 380 cSt or 35 to 2000 SUS	
Filtration	Minimum cleanliness (ISO 4406 1999, 4/6/14 µm) 19/17/14	
Valve Hex Size	0.75 in (19,1 mm)	
Valve Installation Torque	25 - 30 lbf ft (34 - 40 N-m)	
Mounting Position	No restrictions	
Valve Weight (excluding coil)	0.66 lb (0,30 kg)	
Seal Kit - Buna N	990-030-007	
Seal Kit - Viton	990-030-006	
Seal and nut kit - Coil	990-740-006	

*See performance curves starting on page 5 for more details.

TYPICAL PRESSURE DIFFERENTIAL VS. FLOW

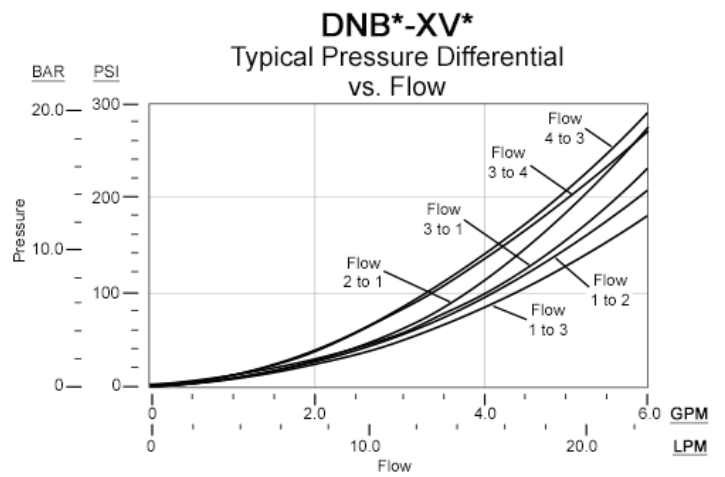
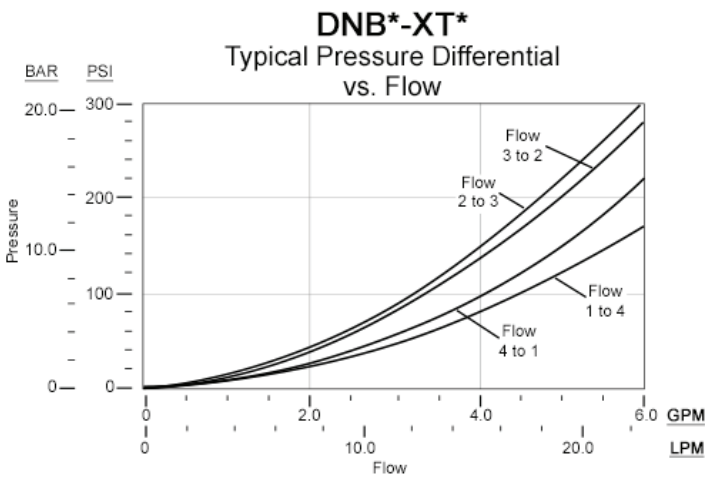
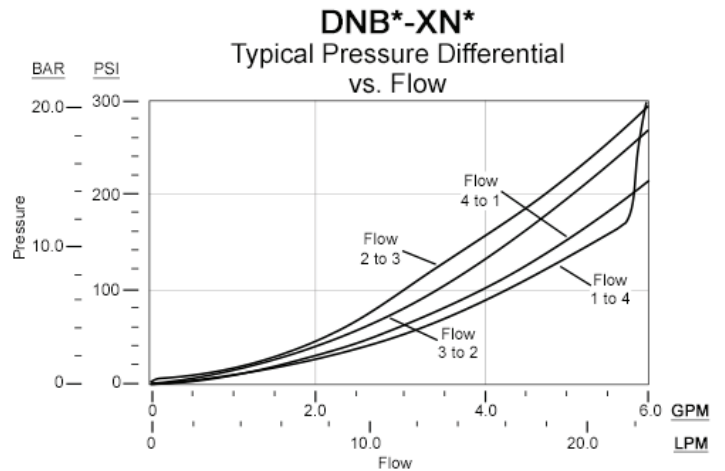
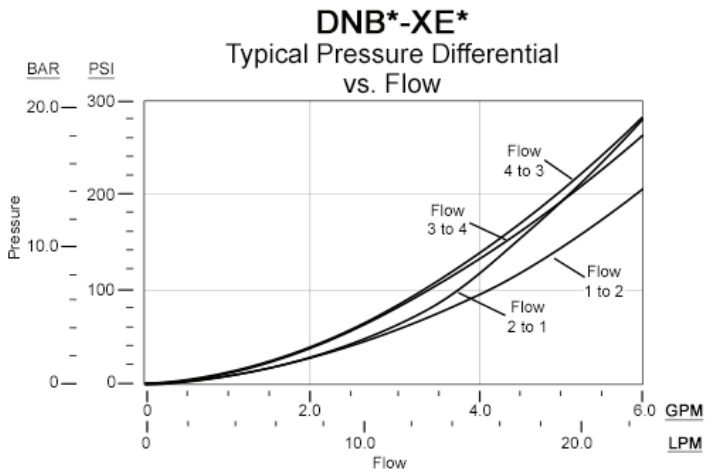
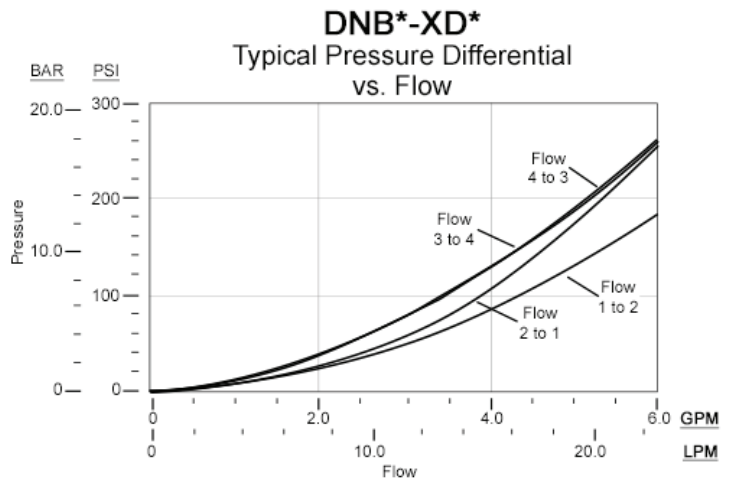
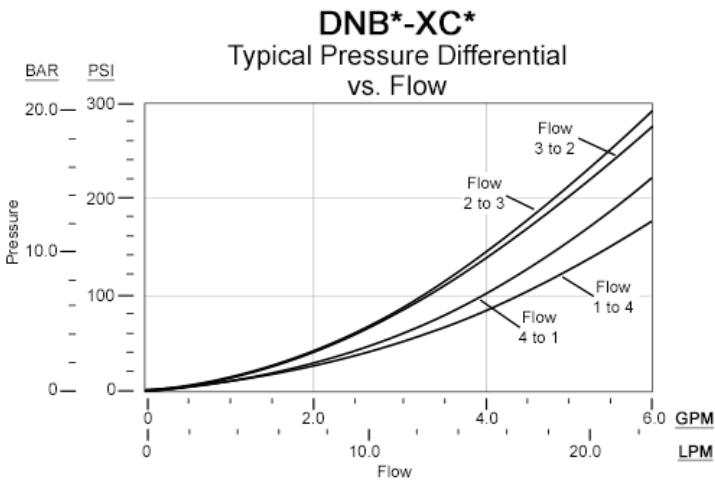

PERFORMANCE LIMITS @15% UNDERVOLTAGE & STABILIZED COIL TEMPERATURE

Note: Performance limits are derived with 4-way operation and symmetrical flow. For valve applications where either asymmetrical flow or 3-way operation is present, these performance limits may be reduced.

DNBD-XC*
with Low-Power Coil

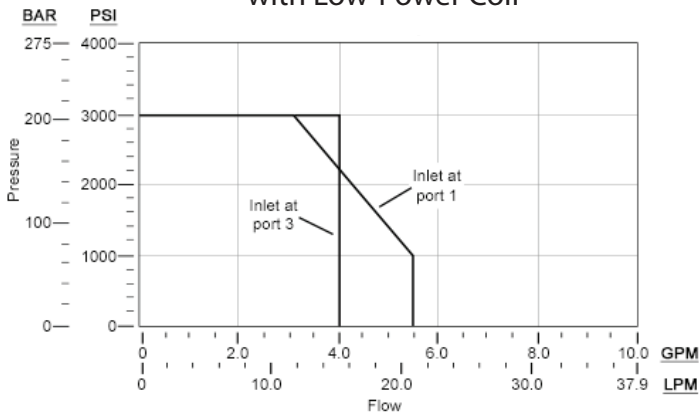

DNBD-XD*
with Low-Power Coil

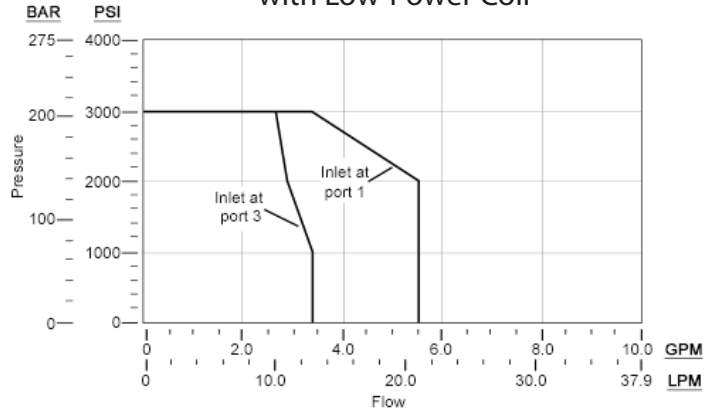

DNBD-XE*
with Low-Power Coil

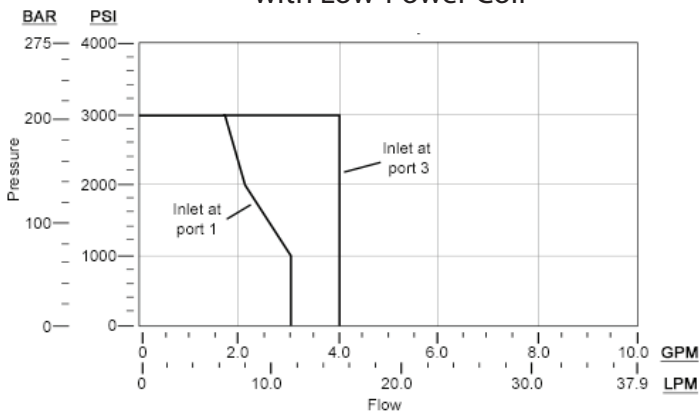

DNBD-XN*
with Low-Power Coil

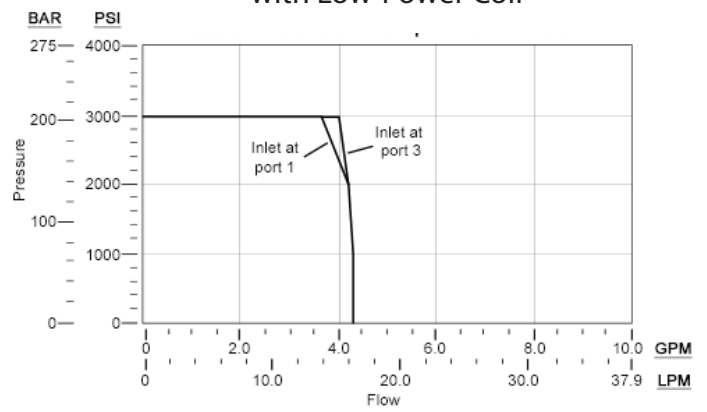

DNBD-XT*
with Low-Power Coil

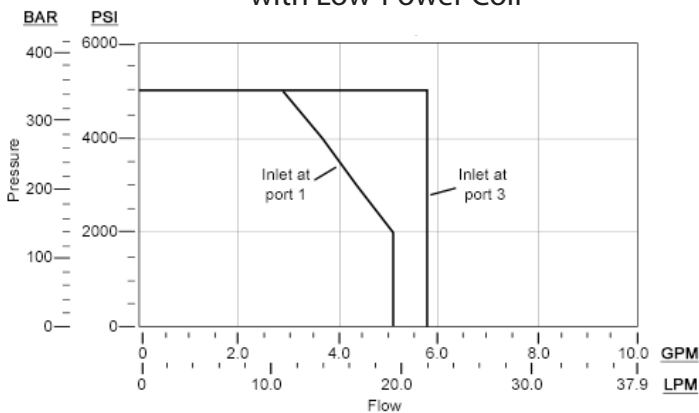

DNBD-XV*
with Low-Power Coil

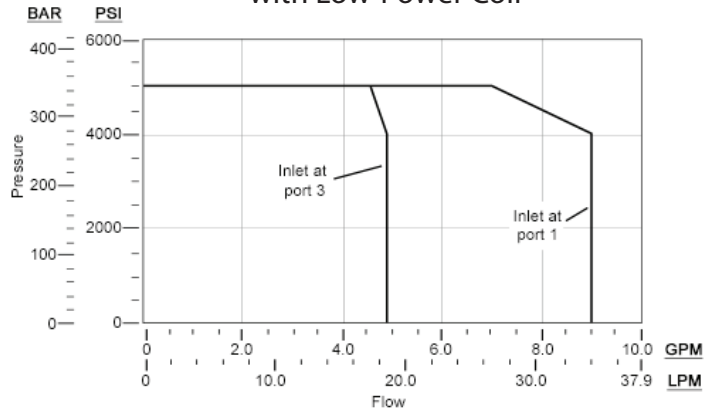

PERFORMANCE LIMITS @15% UNDERVOLTAGE & STABILIZED COIL TEMPERATURE

Note: Performance limits are derived with 4-way operation and symmetrical flow. For valve applications where either asymmetrical flow or 3-way operation is present, these performance limits may be reduced.

DNBF-XC*
with High-Power Coil

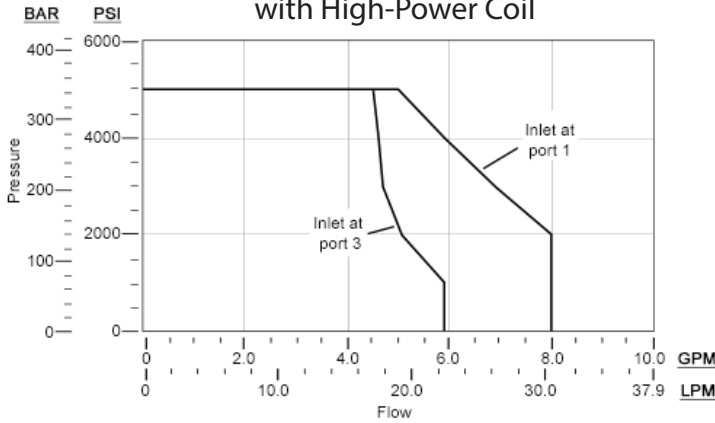

DNBF-XD*
with High-Power Coil

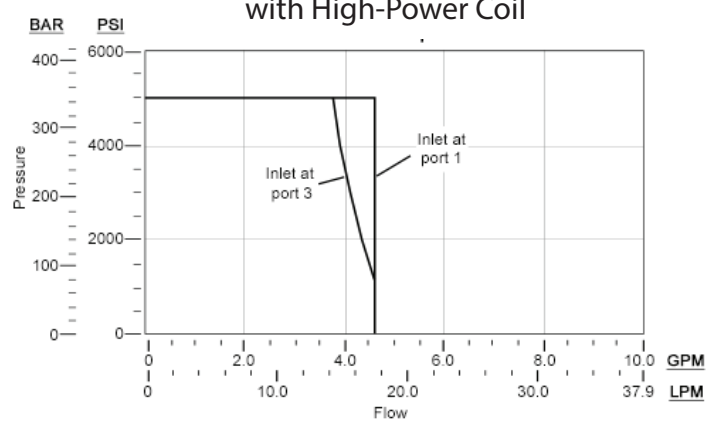

DNBF-XE*
with High-Power Coil

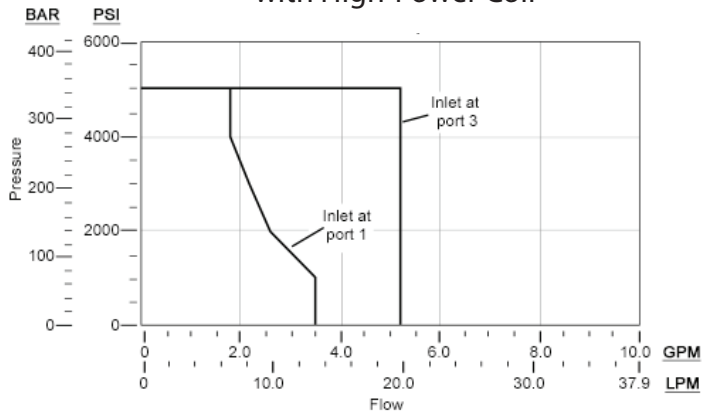

DNBF-XN*
with High-Power Coil

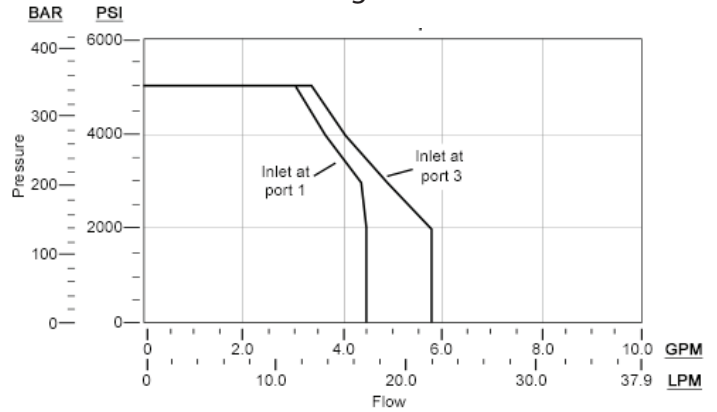

DNBF-XT*
with High-Power Coil

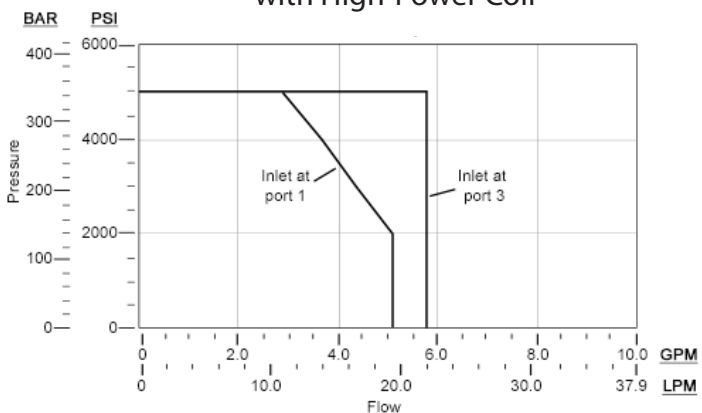

DNBF-XV*
with High-Power Coil

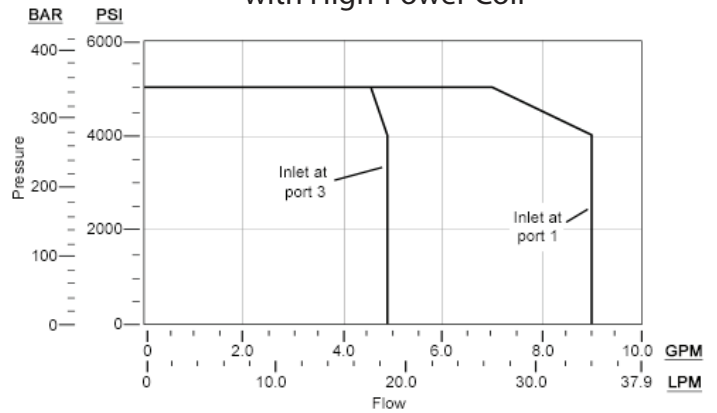

DNB* FAMILY WITH 740 SERIES HIGH-POWER & LOW-POWER COILS

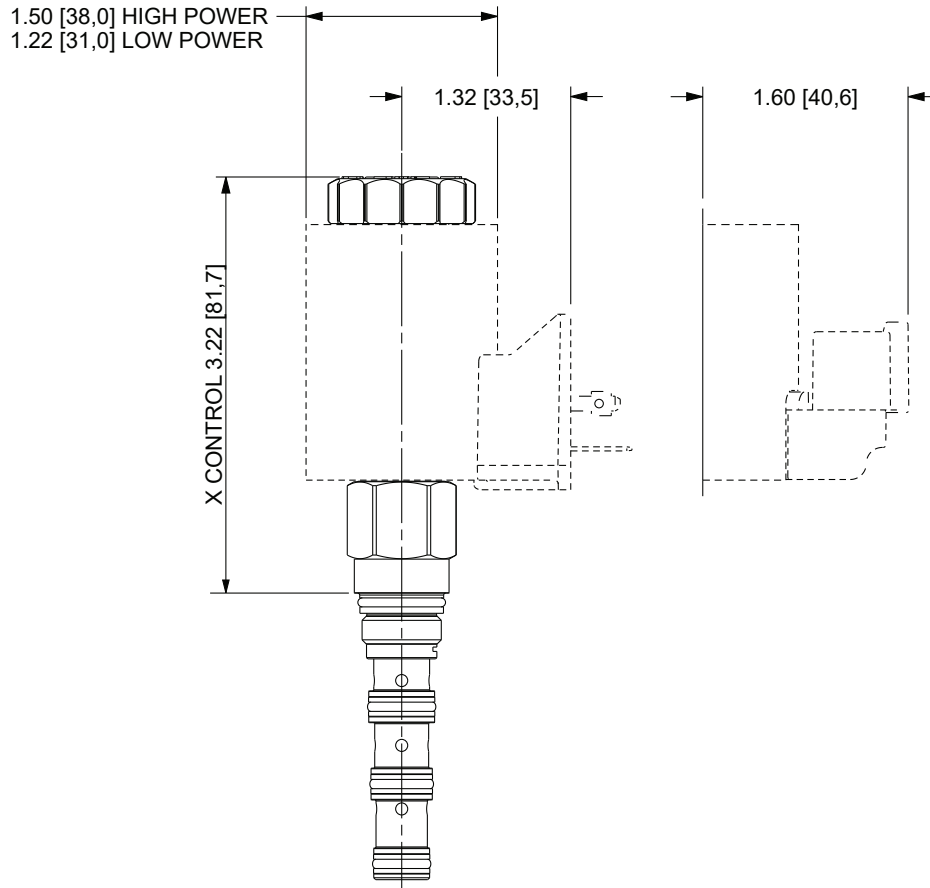

747 SERIES HAZARDOUS LOCATION COILS

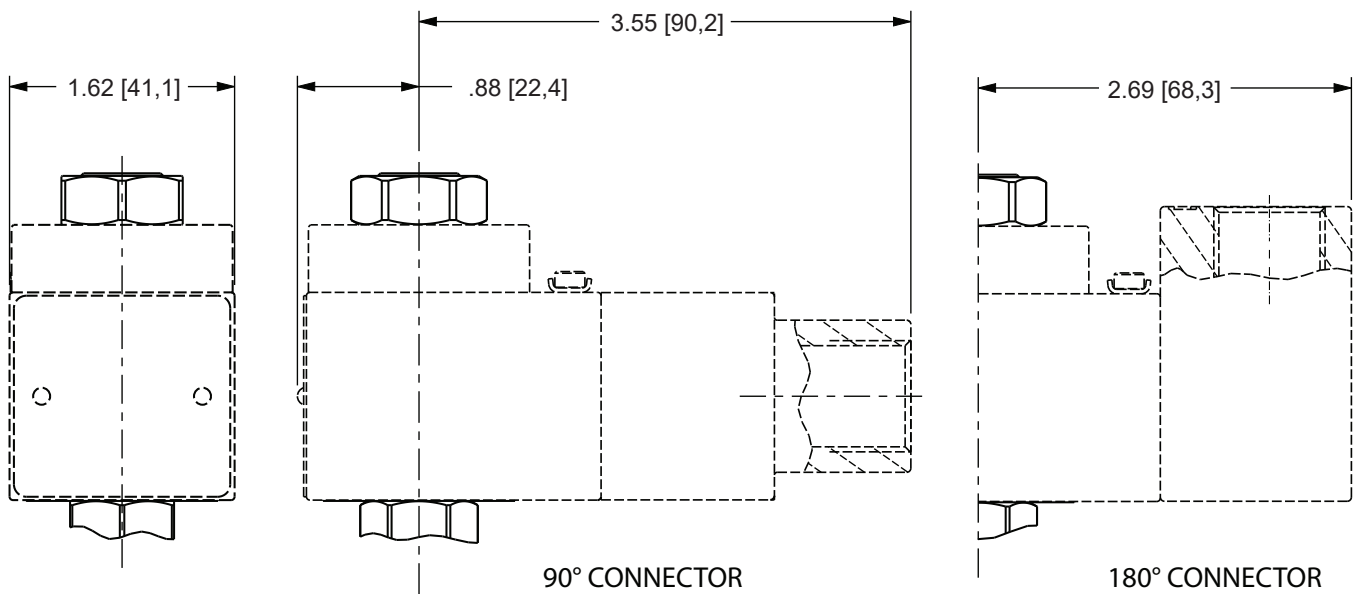

NOTE: Please verify cartridge clearance requirements when choosing a Sun manifold. Different valve controls and coils require different clearances. An additional minimum 2.0 in. (50,8 mm) beyond the valve extension is needed for coil installation and removal.

T-30A CAVITY DIMENSIONAL DRAWING & TOOLING

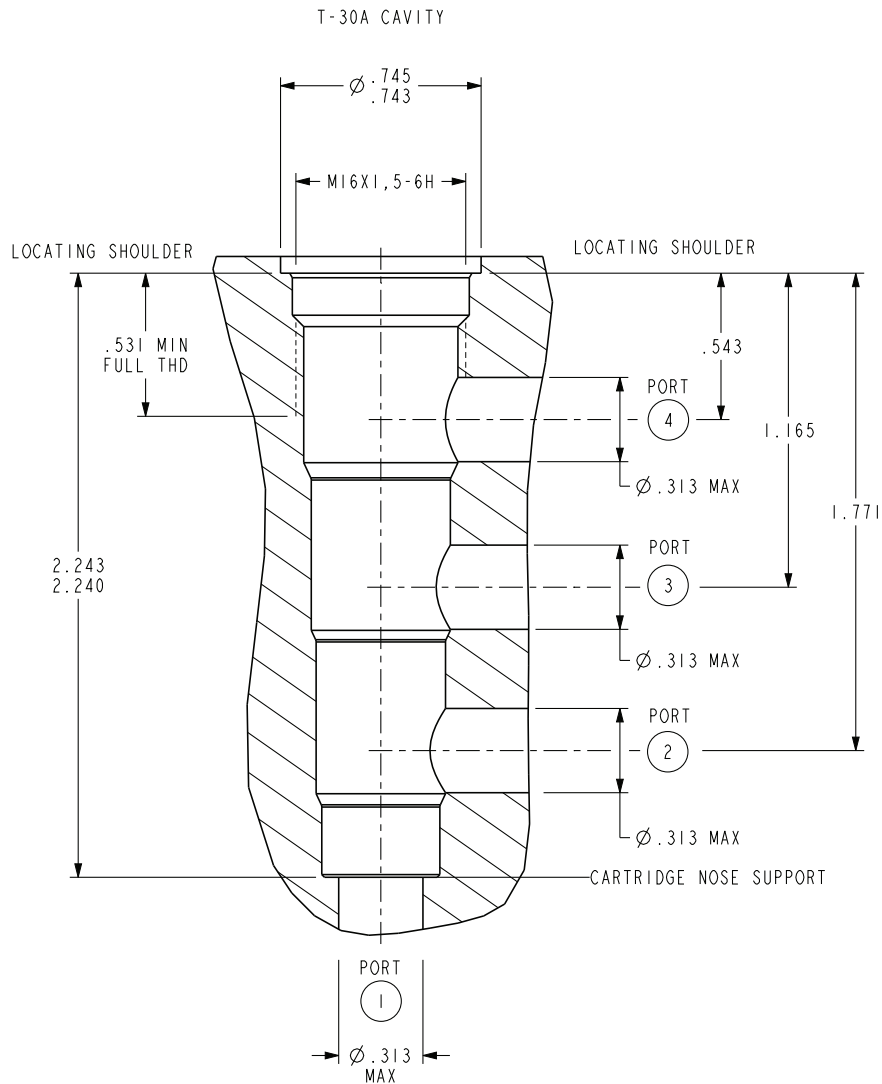

NOTE: For cavity tooling, see table below.

For full cavity detail, download the latest drawings from our website.

<https://www.sunhydraulics.com/cavity/T-30A>

DESCRIPTION	HIGH-SPEED STEEL	TITANIUM COATED
M20 X 1.5-6H tap, straight shank	998991	998991101
Series 1 deep hex socket	998100005	
T-30A cavity form drill, morse taper	994030001	994030101
T-30A cavity form drill, straight shank	994030002	994030102
T-30A cavity form reamer, morse taper	995030001	995030101
T-30A cavity form reamer, straight shank	995030002	995030102

ACCESSORIES

DESCRIPTION	PART NUMBER
Wire harness, 2-pin Deutsch-to-Metri-Pack Conversion	991-717
Wire harness, 2-pin Deutsch-to-Amp Jr Timer Conversion	991-718
Wire harness, 2-pin Deutsch-to-Twin-Lead Conversion	991-719

STANDARD LINE-MOUNT MANIFOLDS

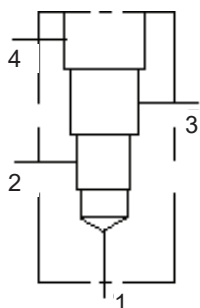

The DNB* family of FLeX valves is based on the new Sun T-30A cavity. Currently, there are six standard single-cavity, 90-degree line mount manifolds available in a wide range of port sizes for the new T-30A cavity. More standard manifolds will be introduced soon, including two-cavity and sandwich style manifolds for this new cavity.

Visit our website to see a complete list of available [standard manifolds for the T-30A cavity](#).



Sun Hydraulics Headquarters
Sarasota, Florida USA
+1 941 362 1200

Custom Fluidpower Pty Ltd
(A Sun Hydraulics Company)
Newcastle, Australia
+61 2 4953 5777
sales@custom.com.au

Sun Hydraulics Limited
Coventry, England
+44 2476 217 400
sales@sunuk.com

Sun Hydraulics Korea Corp.
Incheon, Korea
+82 3281 31350
sales@sunhydraulics.co.kr

Sun Hydraulik GmbH
Erkelenz, Germany
+49 2431 80910
sales@sunhydraulik.de

Sun Hydraulics China Co. Ltd.
Shanghai, P.R. China
+86 2162 375885
sunchinainfo@sunhydraulics.com

Sun Hydraulics Corp. (India)
Bangalore, India
+91 8028 456325
sunindiainfo@sunhydraulics.com

Sun Hydraulics Corp. (S.America)
Rosario, Argentina
+54 9 341 584 3075
ventas@sunhydraulics.com

April 2019