

ATP Art. 282 022 220
Magnetventil Vickers 4/3-Wege
DG4V-3M-2C-VM-KUP5-H7-65 24VDC deutsch
Matchcode: VIC DG4V3M2CVMKUP5H7

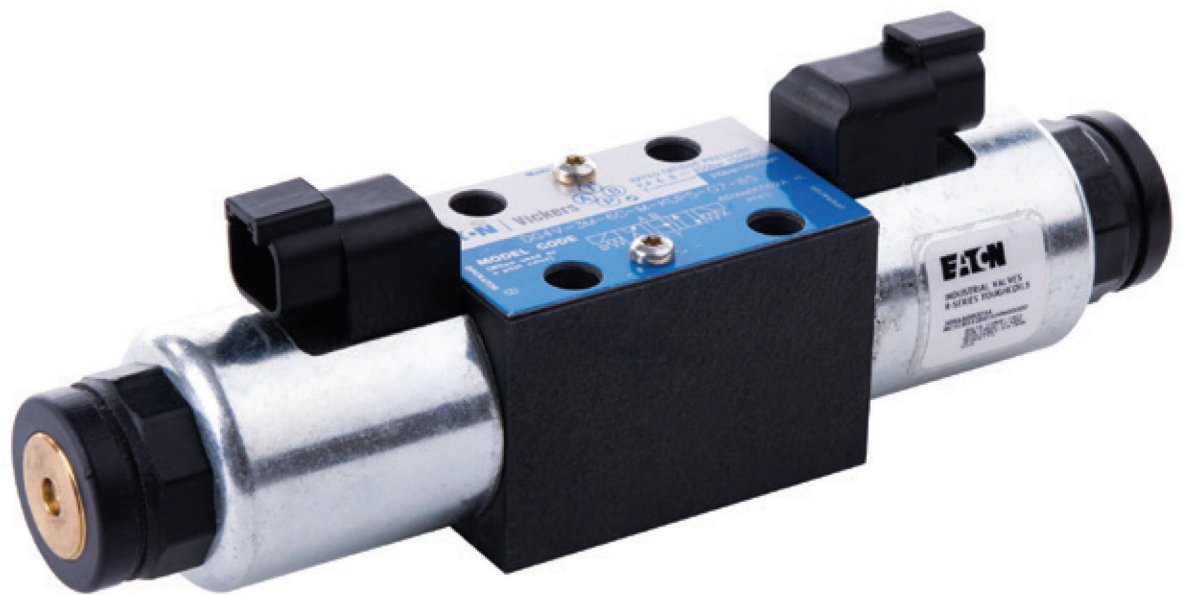

Powering Business Worldwide

Model Code

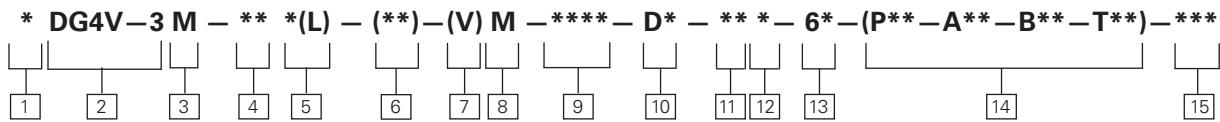

1 Seal Type

Blank – Viton

F6 – Buna Nitrile/High CAN

2 Model series

4 – Solenoid operated

V – Pressure rating 350 bar (5000 psi) on P, A & B ports

3 – ISO4401 Size 03

3 Performance

M – Mobile high performance

4 Spool Type

Please refer functional symbols on Page 5 for spool types.

5 Spool Spring Arrangement

A – Spring offset, end-to-end

AL – Same as “A” but left hand build

B – Spring offset, end to center

BL – Same as “B” but left hand build

C – Spring centered

N – No-spring detented

6 Manual Override Option

Blank – Plain override(s) in solenoid end(s) only ▲

H – Water-resistant override(s) on solenoid end(s) ▲

Z – No overrides at either end

▲ No override in non-solenoid end of single solenoid valves

7 Solenoid Energization Identity

Blank – None

V – Solenoid “A” is at port “A” end and/ or solenoid “B” is at port “B” end, independent of spool type

NOTE: Used to select the identification of the solenoid. Refer to table on page 4.

8 Flag Symbol

M – Electrical options and features

9 Coil Type

U – ISO4400, DIN43650 connector

U1 – ISO4400 fitted with PG11 plug

KUP5 – Integral Deutsch connector

10 Surge Suppressor/ Damper

D – Zener Diode

See Page12 for circuit details

11 Coil Rating

G – 12V DC

GL – 12V DC

H – 24V DC

HL – 24V DC

12 Tank Pressure Rating

Refer to “Operating Data” for port T pressure ratings.

7 – 207 bar (3000 psi)

13 Design Number

65 – Basic design

14 Orifice Plug

00 – No orifice required

03 – 0.3 mm dia.

06 – 0.6 mm dia.

08 – 0.8 mm dia.

09 – 0.9 mm dia.

10 – 1.0 mm dia.

13 – 1.3 mm dia.

15 – 1.5 mm dia.

20 – 2.0 mm dia.

23 – 2.3 mm dia.

15 Reverse Coil Option

RC – Both Coils reversed

RCA – A Coil Reversed

RCB – B coil reversed

NOTE: See page 10.

Functional Symbols

Spool Options

The valve function schematics apply to both U.S. and European valves.

DG4V-3(S)-*NV

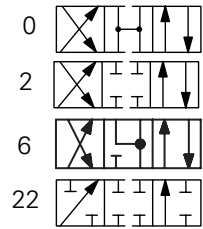

DG4V-3(S)-*AV

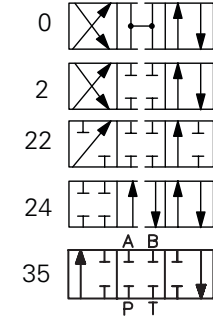

DG4V-3(S)-*ALV

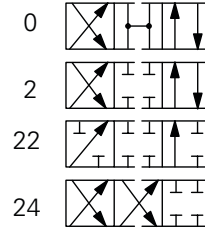

DG4V-3(S)-*CV

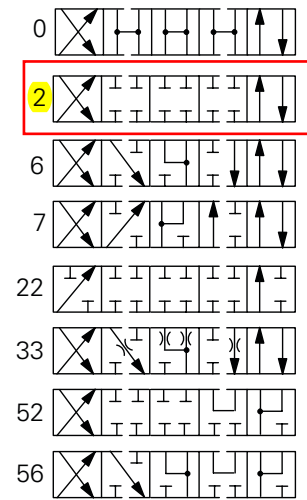

DG4V-3(S)-*BV

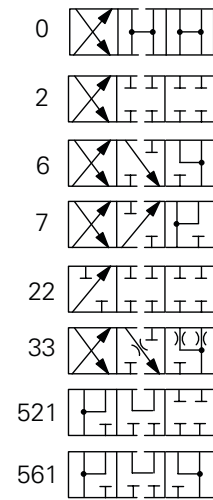

DG4V-3(S)-*BLV

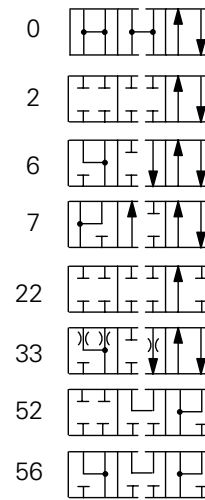

DG4V-3(S)-8CV



DG4V-3(S)-8BLV

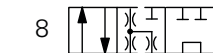

DG4V-3(S)-8BV



Solenoid Identified to US and European Standards

	U.S. Solenoid Standard	European Solenoid Standard (specify "V" in the model code at position 7 on page 3)
Double solenoid valves, two position, detented		
Double solenoid valves, spring centered		
Single solenoid valves, solenoid at port A end		
Single solenoid valves, solenoid at port B end		

▲ Transient condition only



Operating Data

Feature	DG4V-3M
Pressure Limits P, A and B ports	350 bar (5075 psi)
T port:	210 bar (3045 psi)
Flow rating	See performance data
Relative duty factor	Continuous; ED = 100%
Type of protection: ISO 4400 coils with plug fitted correctly	IP69K for Deutsch type IP65 for DIN type
Coil winding	Class H
Coil encapsulation	Class F
Permissible voltage fluctuation:	
Maximum	Refer to temperature limits.
Minimum	90% rated
Typical response times at 100% rated volts measured from application/removal of voltage to full spool displacement of "2C" spool at:	
Flow rate P-A, B-T	20 l/min (5.3 USgpm)
Pressure	175 bar (2537 psi)
AC (~) energizing	18 ms
AC (~) de-energizing	32 ms
DC (=) energizing	60 ms
DC (=) de-energizing	40 ms

Power consumption, DC solenoids at rated voltage and 20 C (68 F).

Full power coils:

12V, model type "G"	30W
24V, model type "H"	30W

Low power coils:

12V, model type "GL"	18W
24V, model type "HL"	18W

▲ 1st half cycle; armature fully retracted.

Performance Data

Pressure drops

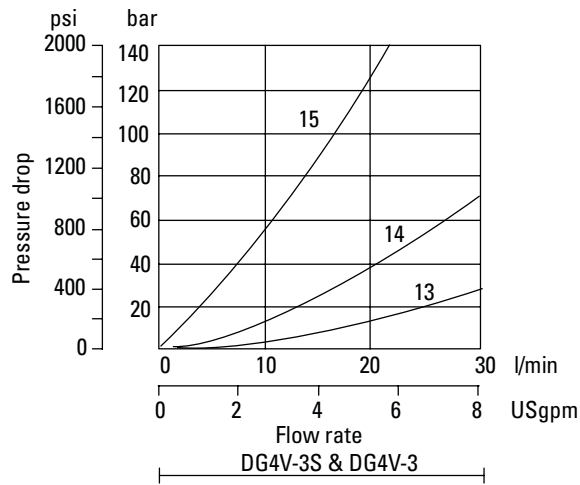
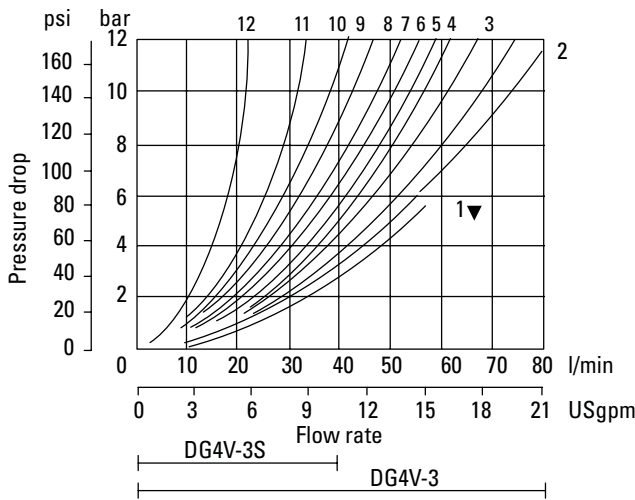

▼ Curve for spool type 6: not recommended for flows in excess of 60 l/min (15.8 USgpm).

Pressure drops in offset positions except where otherwise indicated

Spool/spring code	Spool positions covered	P to A	P to B	A to T	B to T	P to T	B to A or A to B
0A(L)	Both	5	5	2	2	—	—
0B(L) & 0C	De-energized	—	—	—	—	4▲▲	—
	Energized	4	4	2	2	—	—
2A(L)	Both	6	6	5	5	—	—
2B(L) & 2C	Energized	5	5	2	2	—	—
2N	Both	6	6	3	3	—	—
6B(L) & 6C	De-energized	—	—	3▲	3Δ	—	—
	Energized	6	6	1	1	—	—
7B(L) & 7C	De-energized	6▲	6Δ	—	—	—	7○
	Energized	4	4	3	3	—	—
8B(L) & 8C	All	9	9	5	5	3	—
22A(L), 22B(L) & 22C	All	6	6	—	—	—	—
24A(L)	De-energized	6	6	2	2	—	—
33B(L) & 33C	De-energized	—	—	15▲	15Δ	—	—
	Energized	5	5	2	2	—	—
52BL & 52C	Energized	6▲	6Δ	2	—	—	10○
56BL	Both	6▲	6Δ	11▲	10Δ	—	10○
56C	De-energized	—	—	11▲	10Δ	—	10○
	Energized	6▲	6Δ	2	—	—	10○
521B	All	6▲	6Δ	—	—	—	10○
561B	De-energized	—	—	10▲	11Δ	—	10○
	Energized	6	6Δ	—	—	—	10○

▲ "B" plugged Δ "A" plugged ○ "P" plugged

For other viscosities, pressure drops approximate to:

Viscosity cSt (SUS)						
14	20	43	54	65	76	85
(17.5)	(97.8)	(200)	(251)	(302)	(352)	(399)
% of Δp						
81	88	104	111	116	120	124

A change to another specific gravity will yield an approximately proportional change in pressure drop.

The specific gravity of a fluid may be obtained from its producer. Fire resistant fluids usually have higher specific gravities than oil.

Installation Dimension

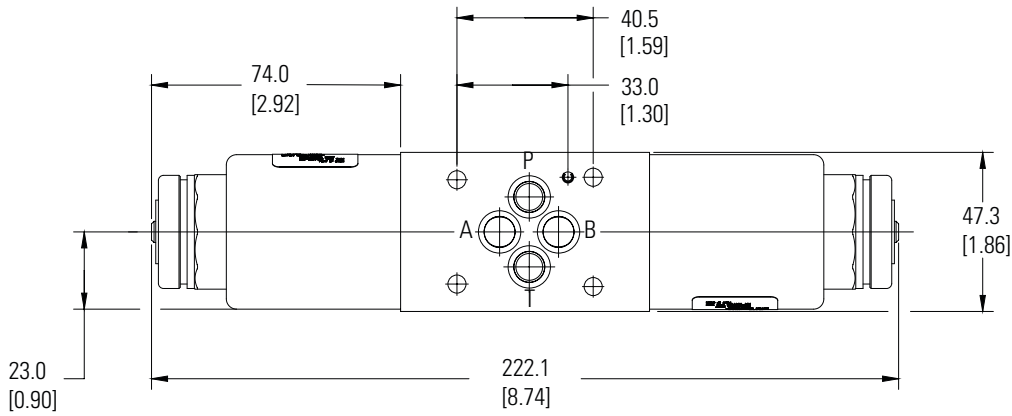
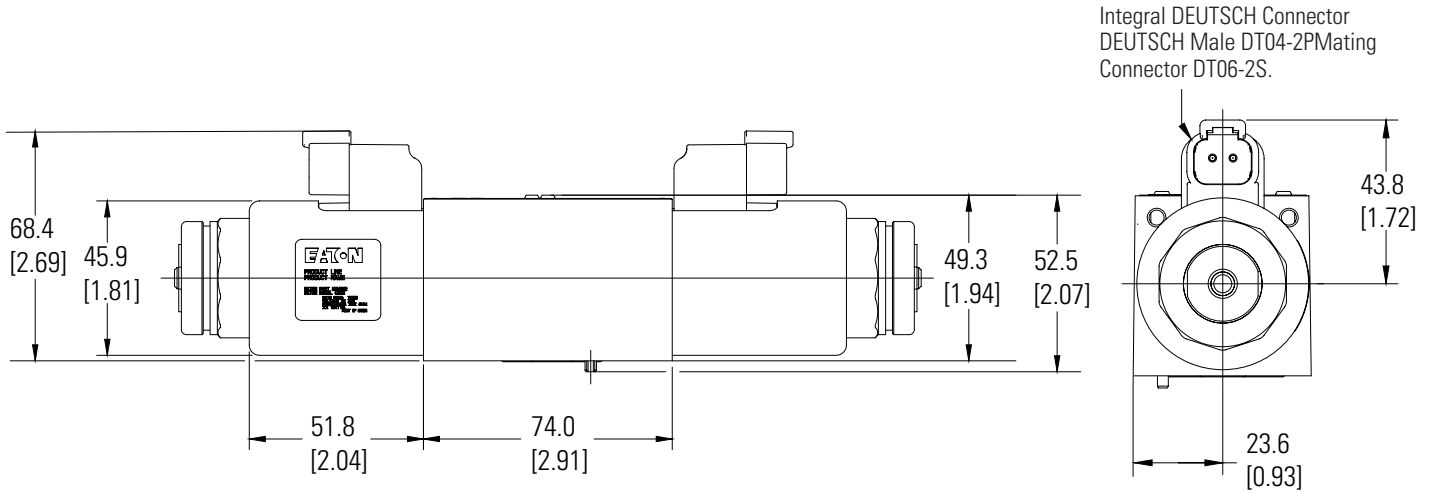

DG4V-3M-0C-M- KUP5-G7-65

Reversed Coil at both sides

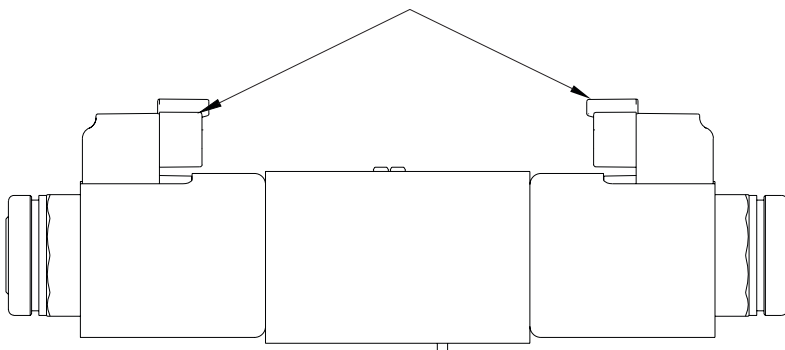

DG4V-3M-0C-M-KUP5-G7-65-RC

Note: Option RCA will have Coil at A port reversed and Option RCB will have coil at B port reversed.



available at:
www.atphydraulik.ch
sales@atphydraulik.ch