

ATP Art. 282 012 010  
Magnetventil Vickers 4/2-Wege  
DG4V-3M-0A-VM-KUP5-G7-65 12VDC deutsch  
Matchcode: VIC DG4V3M0AVMKUP5G7

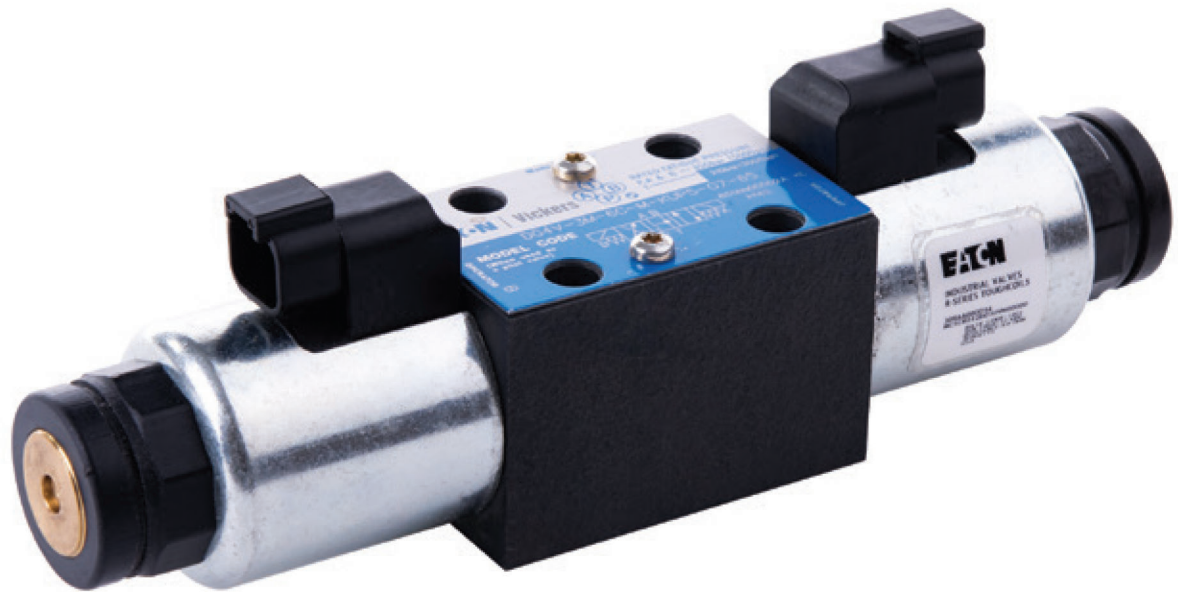

# Model Code

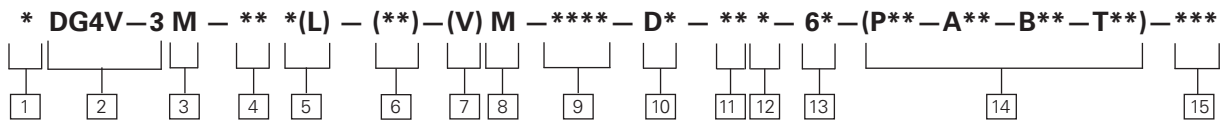

## 1 Seal Type

**Blank** – Viton

**F6** – Buna Nitrile/High CAN

## 2 Model series

**4** – Solenoid operated

**V** – Pressure rating 350 bar (5000 psi) on P, A & B ports

**3** – ISO4401 Size 03

## 3 Performance

**M** – Mobile high performance

## 4 Spool Type

Please refer functional symbols on Page 5 for spool types.

## 5 Spool Spring Arrangement

**A** – Spring offset, end-to-end

**AL** – Same as “A” but left hand build

**B** – Spring offset, end to center

**BL** – Same as “B” but left hand build

**C** – Spring centered

**N** – No-spring detented

## 6 Manual Override Option

**Blank** – Plain override(s) in solenoid end(s) only ▲

**H** – Water-resistant override(s) on solenoid end(s) ▲

**Z** – No overrides at either end

▲ No override in non-solenoid end of single solenoid valves

## 7 Solenoid Energization Identity

**Blank** – None

**V** – Solenoid “A” is at port “A” end and/ or solenoid “B” is at port “B” end, independent of spool type

**NOTE:** Used to select the identification of the solenoid. Refer to table on page 4.

## 8 Flag Symbol

**M** – Electrical options and features

## 9 Coil Type

**U** – ISO4400, DIN43650 connector

**U1** – ISO4400 fitted with PG11 plug

**KUP5** – Integral Deutsch connector

## 10 Surge Suppressor/ Damper

**D** – Zener Diode

See Page12 for circuit details

## 11 Coil Rating

**G** – 12V DC

**GL** – 12V DC

**H** – 24V DC

**HL** – 24V DC

## 12 Tank Pressure Rating

Refer to “Operating Data” for port T pressure ratings.

**7** – 207 bar (3000 psi)

## 13 Design Number

**65** – Basic design

## 14 Orifice Plug

**00** – No orifice required

**03** – 0.3 mm dia.

**06** – 0.6 mm dia.

**08** – 0.8 mm dia.

**09** – 0.9 mm dia.

**10** – 1.0 mm dia.

**13** – 1.3 mm dia.

**15** – 1.5 mm dia.

**20** – 2.0 mm dia.

**23** – 2.3 mm dia.

## 15 Reverse Coil Option

**RC** – Both Coils reversed

**RCA** – A Coil Reversed

**RCB** – B coil reversed

**NOTE:** See page 10.

# Functional Symbols

## Spool Options

The valve function schematics apply to both U.S. and European valves.

### DG4V-3(S)-\*NV

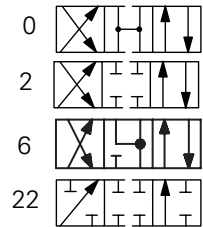

### DG4V-3(S)-\*AV

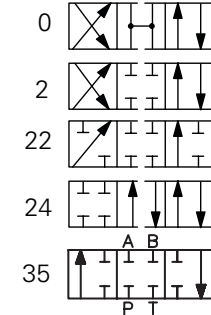

### DG4V-3(S)-\*ALV

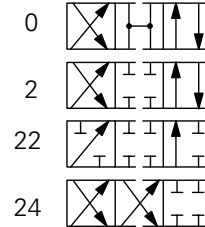

### DG4V-3(S)-\*CV

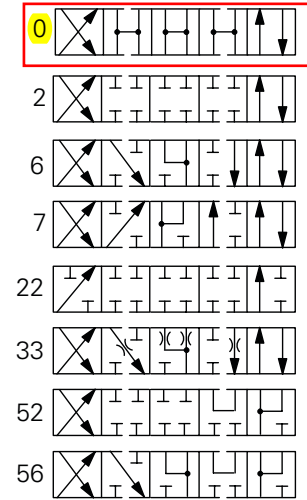

### DG4V-3(S)-\*BV

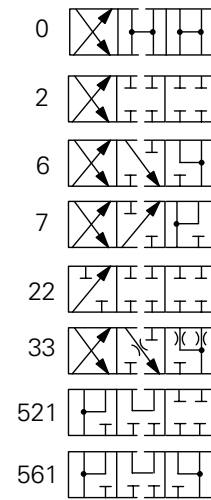

### DG4V-3(S)-\*BLV

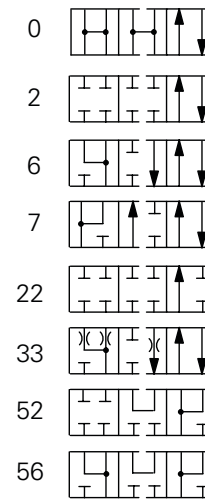

### DG4V-3(S)-8CV



### DG4V-3(S)-8BLV

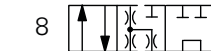

### DG4V-3(S)-8BV

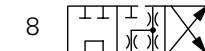

## Solenoid Identified to US and European Standards

### U.S. Solenoid Standard

### European Solenoid Standard (specify "V" in the model code at position 7 on page 3)

Double solenoid valves, two position, detented

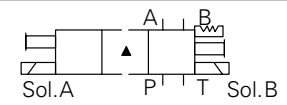
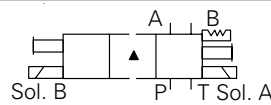

Double solenoid valves, spring centered

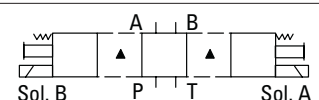
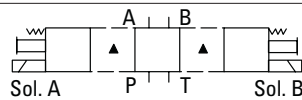

Single solenoid valves, solenoid at port A end

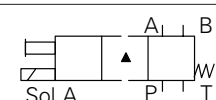
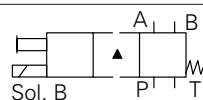

Single solenoid valves, solenoid at port B end

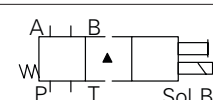
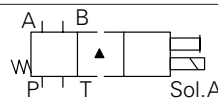

▲ Transient condition only

# Operating Data

Feature	DG4V-3M
Pressure Limits P, A and B ports	350 bar (5075 psi)
T port:	210 bar (3045 psi)
Flow rating	See performance data
Relative duty factor	Continuous; ED = 100%
Type of protection: ISO 4400 coils with plug fitted correctly	IP69K for Deutsch type IP65 for DIN type
Coil winding	Class H
Coil encapsulation	Class F
<b>Permissible voltage fluctuation:</b>	
Maximum	Refer to temperature limits.
Minimum	90% rated
<b>Typical response times at 100% rated volts measured from application/removal of voltage to full spool displacement of "2C" spool at:</b>	
Flow rate P-A, B-T	20 l/min (5.3 USgpm)
Pressure	175 bar (2537 psi)
AC (~) energizing	18 ms
AC (~) de-energizing	32 ms
DC (=) energizing	60 ms
DC (=) de-energizing	40 ms

## Power consumption, DC solenoids at rated voltage and 20 C (68 F).

### Full power coils:

12V, model type "G"	30W
24V, model type "H"	30W

### Low power coils:

12V, model type "GL"	18W
24V, model type "HL"	18W

▲ 1<sup>st</sup> half cycle; armature fully retracted.

# Performance Data

## Pressure drops

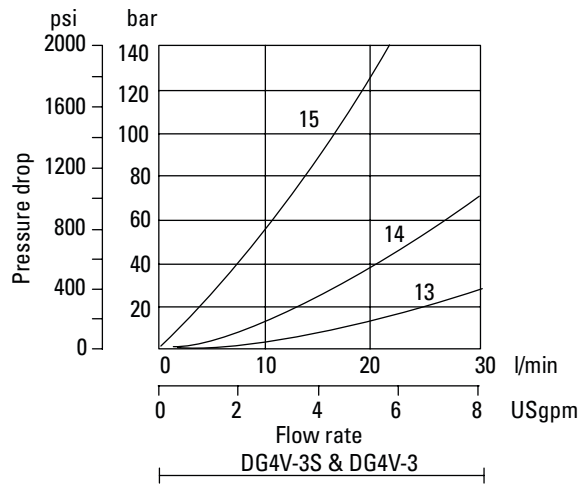
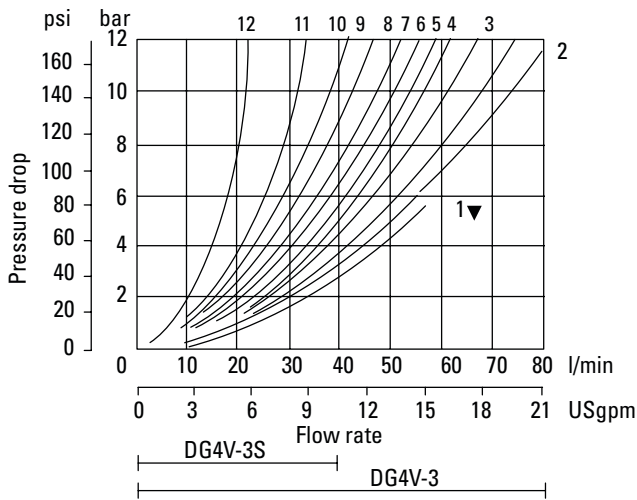

▼ Curve for spool type 6: not recommended for flows in excess of 60 l/min (15.8 USgpm).

## Pressure drops in offset positions except where otherwise indicated

Spool/spring code	Spool positions covered	P to A	P to B	A to T	B to T	P to T	B to A or A to B
0A(L)	Both	5	5	2	2	—	—
0B(L) & 0C	De-energized	—	—	—	—	4▲▲	—
	Energized	4	4	2	2	—	—
2A(L)	Both	6	6	5	5	—	—
2B(L) & 2C	Energized	5	5	2	2	—	—
2N	Both	6	6	3	3	—	—
6B(L) & 6C	De-energized	—	—	3▲	3Δ	—	—
	Energized	6	6	1	1	—	—
7B(L) & 7C	De-energized	6▲	6Δ	—	—	—	7○
	Energized	4	4	3	3	—	—
8B(L) & 8C	All	9	9	5	5	3	—
22A(L), 22B(L) & 22C	All	6	6	—	—	—	—
24A(L)	De-energized	6	6	2	2	—	—
33B(L) & 33C	De-energized	—	—	15▲	15Δ	—	—
	Energized	5	5	2	2	—	—
52BL & 52C	Energized	6▲	6Δ	2	—	—	10○
56BL	Both	6▲	6Δ	11▲	10Δ	—	10○
56C	De-energized	—	—	11▲	10Δ	—	10○
	Energized	6▲	6Δ	2	—	—	10○
521B	All	6▲	6Δ	—	—	—	10○
561B	De-energized	—	—	10▲	11Δ	—	10○
	Energized	6	6Δ	—	—	—	10○

▲ "B" plugged    Δ "A" plugged    ○ "P" plugged

For other viscosities, pressure drops approximate to:

Viscosity cSt (SUS)						
14	20	43	54	65	76	85
(17.5)	(97.8)	(200)	(251)	(302)	(352)	(399)
% of Δp						
81	88	104	111	116	120	124

A change to another specific gravity will yield an approximately proportional change in pressure drop.

The specific gravity of a fluid may be obtained from its producer. Fire resistant fluids usually have higher specific gravities than oil.

# Installation Dimension

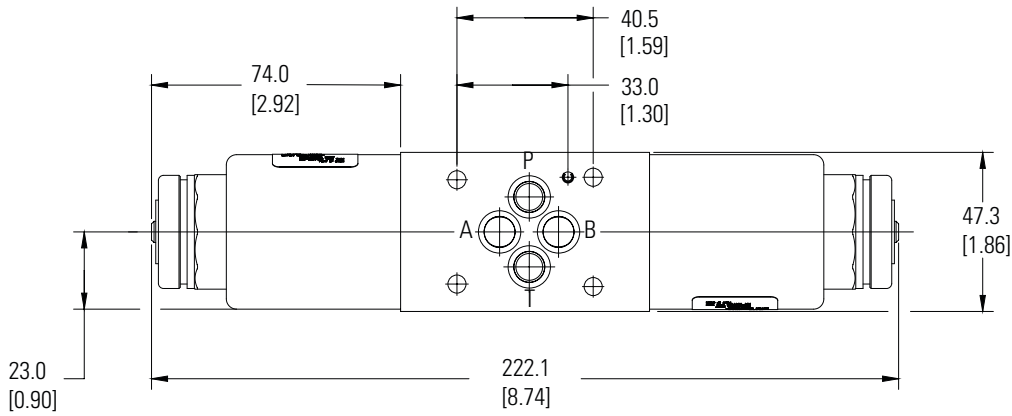
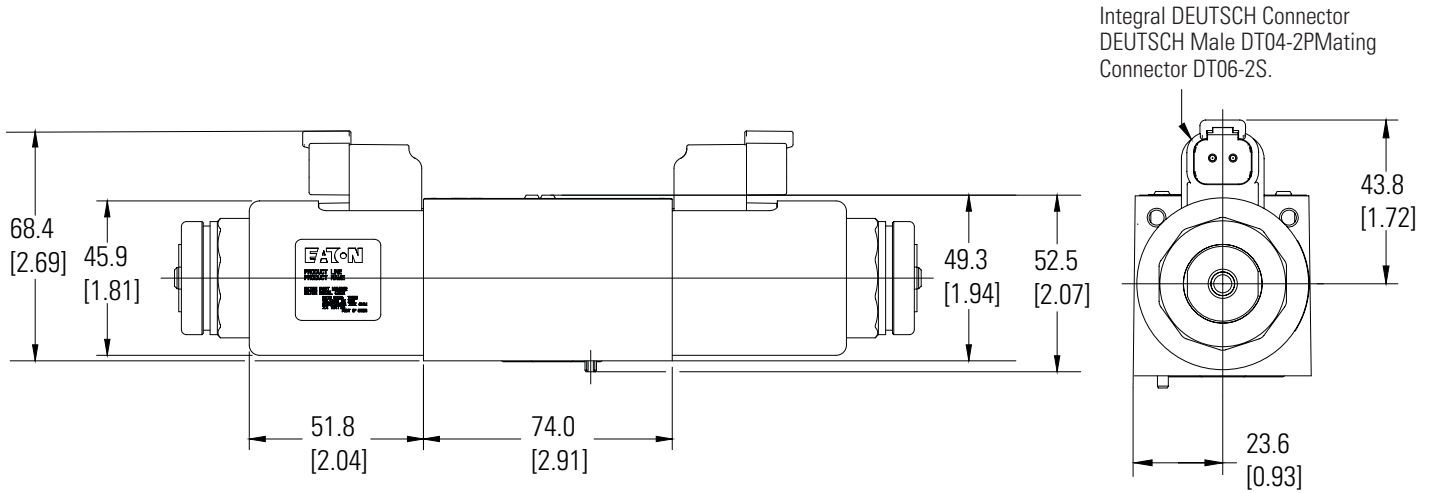

**DG4V-3M-0C-M- KUP5-G7-65**

**Reversed Coil at both sides**

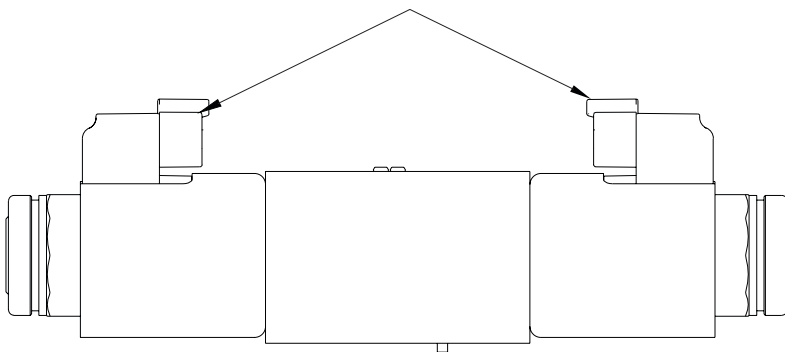

**DG4V-3M-0C-M-KUP5-G7-65-RC**

**Note:** Option RCA will have Coil at A port reversed and Option RCB will have coil at B port reversed.



available at:  
www.atphydraulik.ch  
sales@atphydraulik.ch